

Hacheurs 45V - 5A

Carte Moteur V7
Robot Club Toulonnais

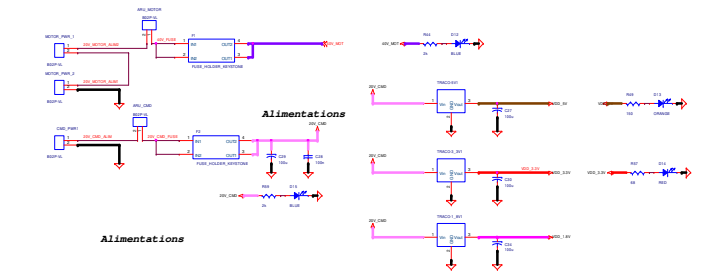

Alimentations

Alimentations

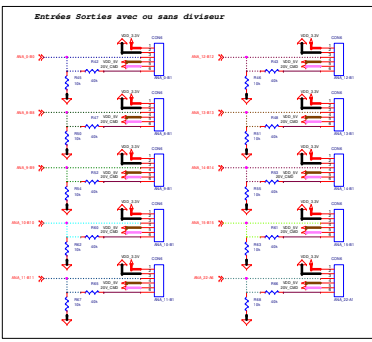

Entrées Sorties avec ou sans diviseur

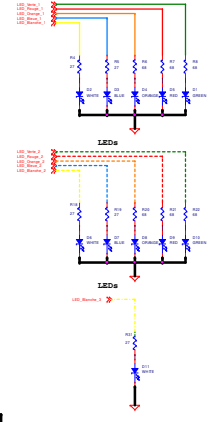

LEDs

LEDs

USB LEDs

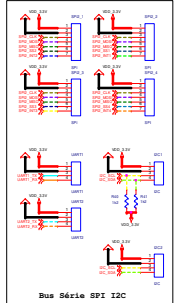

Bus Série SPI I2C

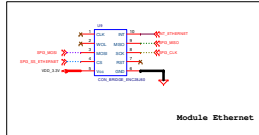

Module Ethernet

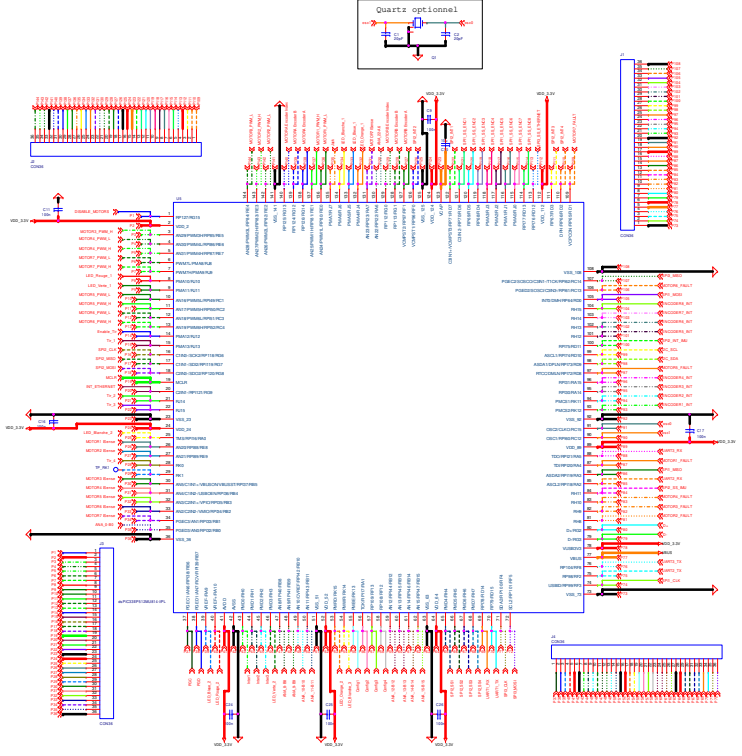

Quartz optionnel

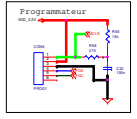

Programmeur

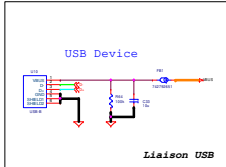

USB Device

Liaison USB

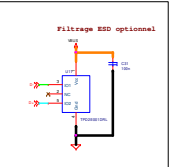

Filtrage ESD optionnel

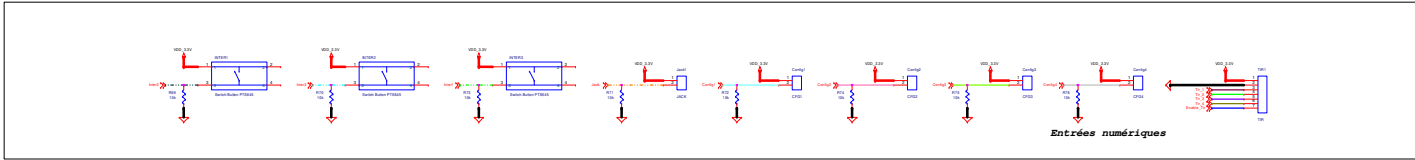

Entrées numériques

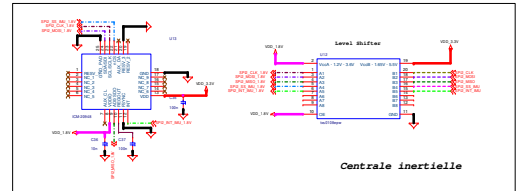

Centrale inertielle

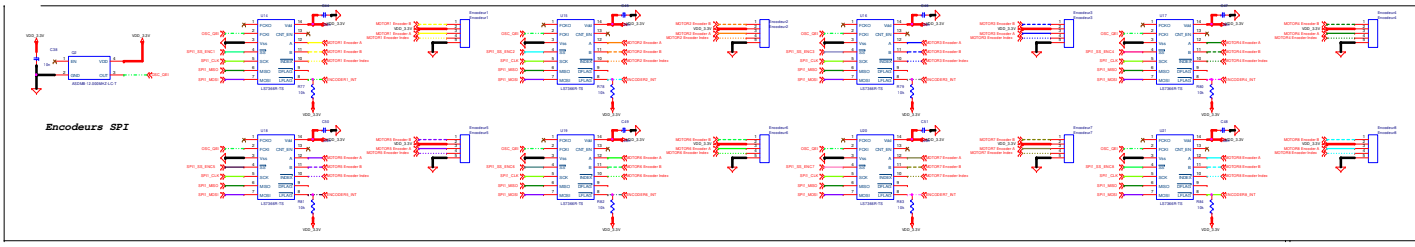

Encodeurs SPI

Encodeurs dePIC

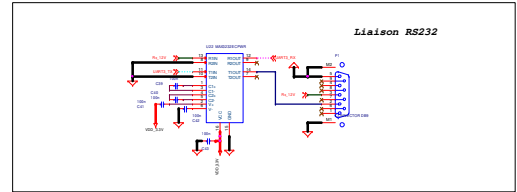

Liaison RS232